

General tolerances ISO 2768-m						Index	Date	Visum	Modification	Index	Date	Visum	Modification
Basic-size	...6	> 6 ...30	> 30 ...120	>120 ...400	> 400 ...1000								
medium	±0.1	±0.2	±0.3	±0.5	±0.8								

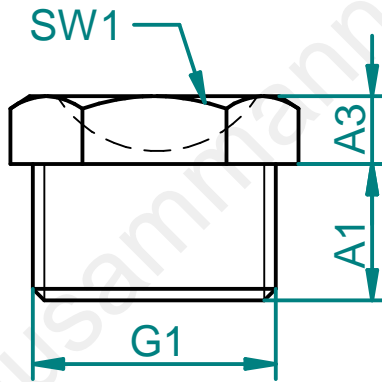

www.hausammann.com

Specifications points D,K,H	
D= doc.points	
K= critical	
H= main	

Accord-draw.no.: Origin-draw.no.: Replacement for:	Material:			
	Stahl verzinkt			
	Scale			
	04.000			
<b>HAUSAMMANN</b> KOMONENTEN PRODUKTION SYSTEME		<input type="checkbox"/> Date plotted 27.06.11 checked	<input type="checkbox"/> Visum E.Z	<input type="checkbox"/> Phone
		<b>Solid Edge</b>	Format <b>A4</b>	Index <b>00</b>
© 2010, Für dieses Dokument behalten wir uns alle Rechte vor.		© 2 010, Nous nous reservons tous les droits sur ce document		© 2 010, We reserve all rights in connection with this document